

**1:1 Transmission Line Transformer, with center tap  
5-1000MHz**

**MABACT0040  
V1P**

**Features**

- Surface Mount
- 1:1 Impedance
- Centre tap on secondary
- 260°C Reflow Compatible
- RoHS\* Compliant
- Available on Tape and Reel. Reel quantity 2000

**Description**

M/A-COM's MABACT0040 is a 1:1 RF Transmission Line transformer in a low cost, surface mount package. Excellent Return Loss. Ideally suited for high volume CATV/Broadband applications.

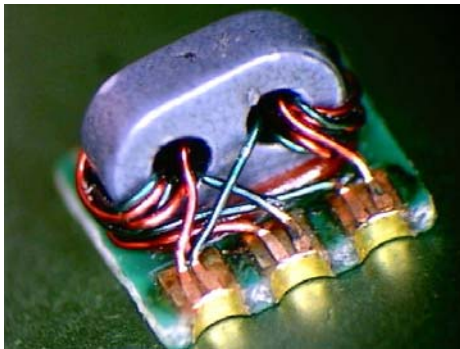

**Schematic**

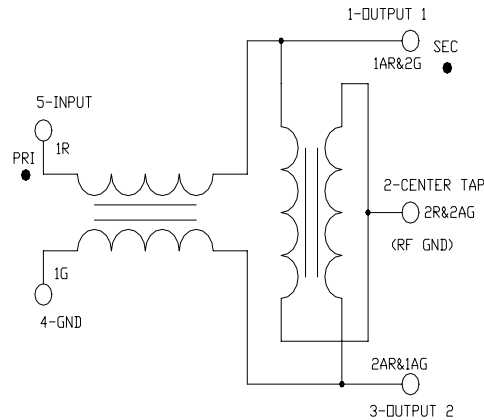

**Case Style: SM-164**

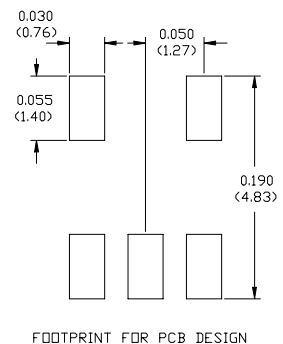
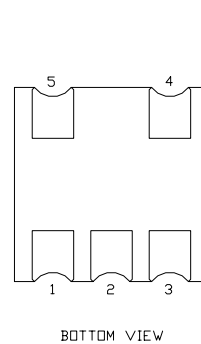
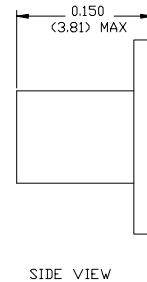
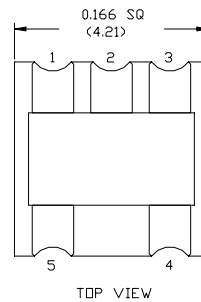

**Pin Configuration**

Pin No.	Function
1	Secondary Dot (Output 1)
2	Secondary centre tap (Ground)
3	Secondary (Output 2)
4	Primary (Ground)
5	Primary Dot (Input)

**Ordering Information**

Part Number	Package
MABACT0040TR	2000 piece reel

Note: Reference Application Note **M513** for reel size information.

\* Restrictions on Hazardous Substances, European Union Directive 2002/95/EC.

M/A-COM Inc. and its affiliates reserve the right to make changes to the product(s) or information contained herein without notice. M/A-COM makes no warranty, representation or guarantee regarding the suitability of its products for any particular purpose, nor does M/A-COM assume any liability whatsoever arising out of the use or application of any product(s) or information.

- **North America** Tel: 800.366.2266 / Fax: 978.366.2266
- **Europe** Tel: 44.1908.574.200 / Fax: 44.1908.574.300
- **Asia/Pacific** Tel: 81.44.844.8296 / Fax: 81.44.844.8298

Visit [www.macom.com](http://www.macom.com) for additional data sheets and product information.

1:1 Transmission Line Transformer, with center tap  
5-1000MHz

MABACT0040  
V1P

**Electrical Specifications:  $T_A = 25^\circ\text{C}$ ,  $Z_0 = 75\Omega$**

Parameter	Test Conditions	Frequency	Units	Min	Typ	Max
Insertion Loss	-	5 - 1000 MHz	dB	-	1.1	1.6
Amplitude Unbalance (Nominal 0dB)	-	5 - 1000 MHz	dB	-	$\pm 0.1$	$\pm 0.5$
Phase Unbalance (Nominal 180°)	-	5 - 1000 MHz	°	-	5	$\pm 10$
Input Return Loss	-	5 - 1000 MHz	dB	16	24	-

### Absolute Maximum Ratings <sup>1,2</sup>

Parameter	Absolute Maximum
Max Input Power	250mW
DC current	240mA
Operating Temperature	-40°C to +85°C
Storage Temperature	-55°C to +100°C

- Exceeding any one or combination of these limits may cause permanent damage to this device.
- M/A-COM does not recommend sustained operation near these survivability limits.

### Recommended PCB Configuration

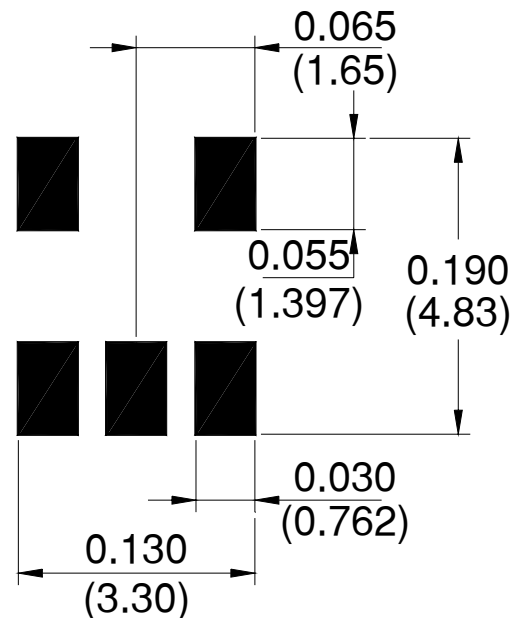

1:1 Transmission Line Transformer, with center tap  
5-1000MHz

MABACT0040  
V1P

Typical Performance Curves:  $T_A = 25^\circ\text{C}$ ,  $Z_0 = 75\Omega$

Insertion Loss 1: Pin 5 to 1

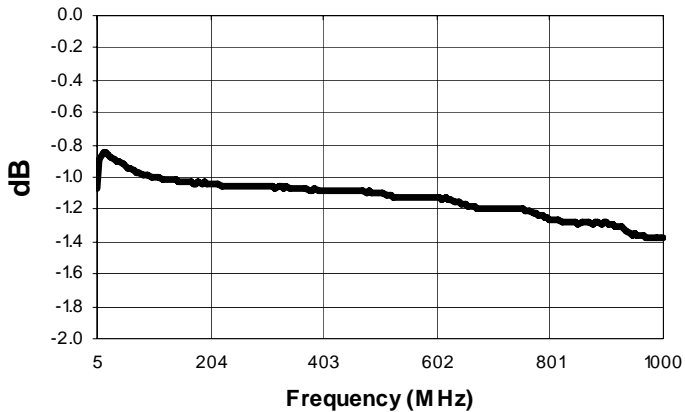

Insertion Loss 2: Pin 5 to 3

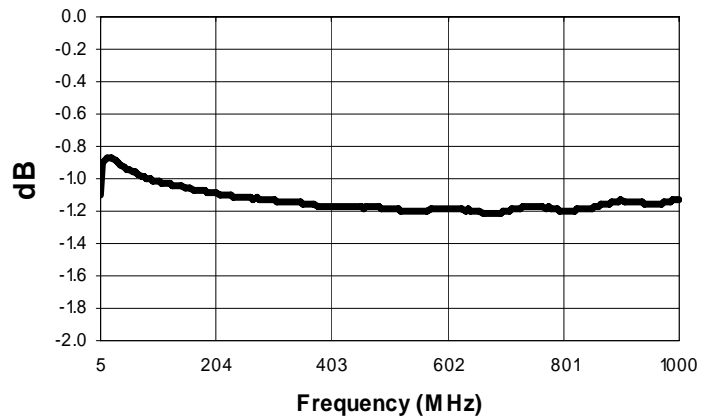

Amplitude Unbalance

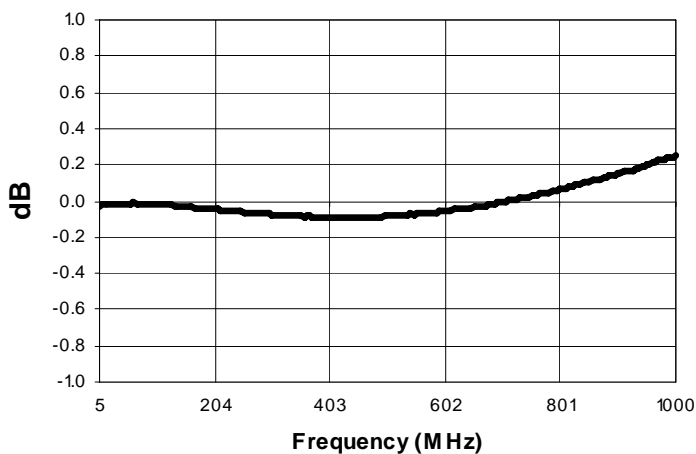

Phase Balance

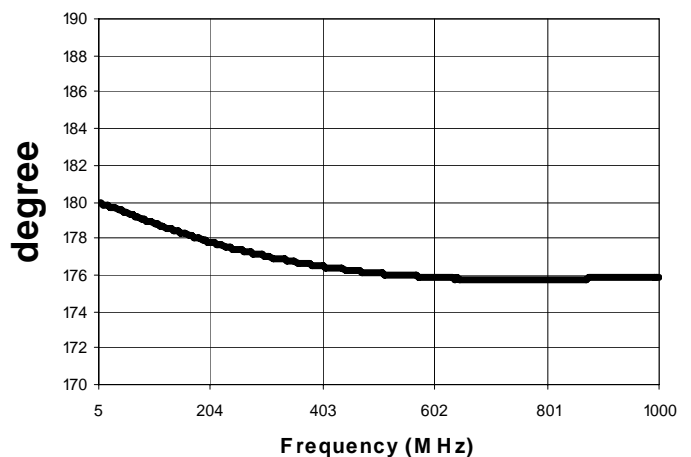

Input Return Loss

